

OWNER'S MANUAL

20" MULCHING MOWERS

Model Numbers
112-170A
112-170-300

Important:
**Read Safety Rules and
Instructions Carefully**

Thank you for purchasing an
American built product.

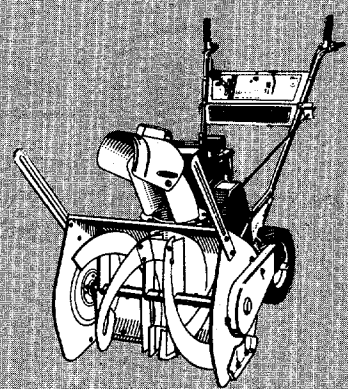
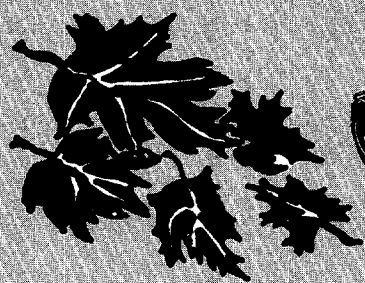
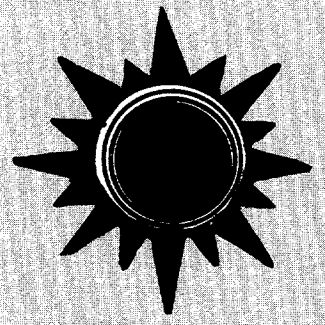
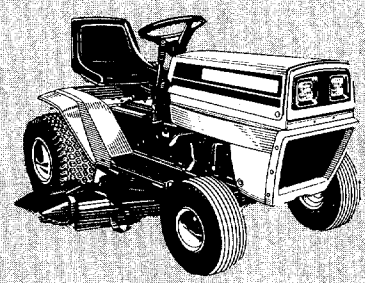
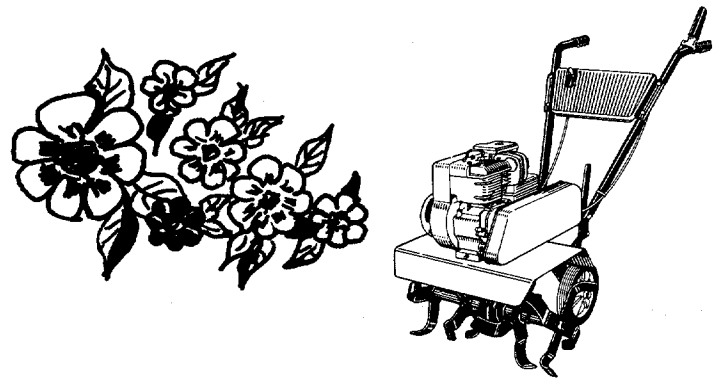

INDEX

Safe Operation Practices	3	Maintenance	9
Assembly	4	Off-Season Storage	11
Operation	6	Illustrated Parts	14
Adjustments	6	Parts List	15
Lubrication	9	Parts Information	Back Cover

LIMITED WARRANTY

For one year from the date of original retail purchase, MTD PRODUCTS INC will either repair or replace, at its option, free of charge, F.O.B. factory or authorized service firm, any part or parts found to be defective in material or workmanship. Transportation charges for the movement of any power equipment unit or attachment are the responsibility of the purchaser. Transportation charges for any parts submitted for replacement under this warranty must be paid by the purchaser unless such return is requested by MTD PRODUCTS INC.

This warranty will not apply to any part which has become inoperative due to misuse, excessive use, accident, neglect, improper maintenance, alterations, or unless the unit has been operated and maintained in accordance with the instructions furnished. This warranty does not apply to the engine, motor, battery, battery charger or component parts thereof. Please refer to the applicable manufacturer's warranty on these items.

This warranty will not apply where the unit has been used commercially.

Warranty service is available through your local authorized service dealer or distributor. If you do not know the dealer or distributor in your area, please write to the Customer Service Department of MTD.

The return of a complete unit will not be accepted by the factory unless prior written permission has been extended by MTD.

This warranty gives you specific legal rights. You may also have other rights which vary from state to state.



WARNING

TO PURCHASERS OF INTERNAL COMBUSTION ENGINE EQUIPPED MACHINERY OR DEVICES IN THE STATE OF CALIFORNIA

The equipment which you have just purchased does not have a spark arrester. If this equipment is used on any forest covered land, brush covered land, or grass covered unimproved land in the State of California, before using on such land, the California law requires that a spark arrester be provided. In addition, spark arrester is required by law to be in effective working order. The spark arrester must be attached to the exhaust system and comply with Section 4442 of the California Public Resources Code.



WARNING

To reduce the potential for any injury, comply with the following safety instructions. Failure to comply with the instructions may result in personal injury.

SAFE OPERATION PRACTICES FOR WALK-BEHIND MOWERS

TRAINING

1. It is suggested that this manual be read in its entirety before attempting to assemble or operate this unit. Keep this manual in a safe place for future reference and for ordering replacement parts.
2. Your rotary mower is a precision piece of power equipment, not a plaything. Therefore, exercise extreme caution at all times.
3. Read this Owner's Manual carefully. Be thoroughly familiar with the controls and the proper use of the equipment.
4. Never allow children to operate a power mower. Only persons well acquainted with these rules of safe operation should be allowed to use your mower.
5. Keep the area of operation clear of all persons, particularly small children and pets. Stop engine when they are in the vicinity of your mower. Although the area of operation should be completely cleared of foreign objects, a small object may have been overlooked and could be accidentally thrown by the mower in any direction and cause injury.
4. After striking a foreign object, stop the engine, remove the wire from the spark plug, and thoroughly inspect the mower for any damage. Repair the damage before restarting and operating the mower.
5. If the equipment should start to vibrate abnormally, stop the engine and check immediately for the cause. Vibration is generally a warning of trouble.
6. Stop the engine whenever you leave the mower, before cleaning the mower housing, and when making any repairs or inspections.
7. When cleaning, repairing or inspecting, make certain the blade and all moving parts have stopped. Disconnect the spark plug wire, and keep the wire away from the plug to prevent accidental starting.
8. Before attempting to unclog the mower or discharge chute, stop the engine and be sure the blade has stopped completely. The cutting blade continues to rotate for a few seconds after the engine is shut off. Never place any part of the body in the blade area until you are sure the blade has stopped rotating. Disconnect the spark plug wire and keep the wire away from the plug to prevent accidental starting.

PREPARATION

1. Thoroughly inspect the area where the equipment is to be used. Remove all stones, sticks, wire, bones and other foreign objects which could be picked up and thrown by the mower in any direction and cause injury.
2. Do not operate equipment when barefoot or wearing open sandals. Always wear substantial footwear.
3. Do not wear loose fitting clothing that could get caught on the mower.
4. Check the fuel before starting the engine. Gasoline is an extremely flammable fuel. Do not fill the gasoline tank indoors, while the engine is running, or while the engine is still hot. Wipe off any spilled gasoline before starting the engine as it may cause a fire or explosion.
5. Disengage the self-propelled mechanism or drive clutch on units so equipped before starting the engine.
6. Never attempt to make a wheel or cutting height adjustment while the engine is running.
7. Mow only in daylight or in good artificial light.
8. Never operate the equipment in wet grass. Always be sure of your footing. Keep a firm hold on the handle and walk, never run.
9. Do not run the engine indoors.
10. Shut the engine off and wait until the blade comes to a complete stop before removing the grass catcher or unclogging chute.
11. Mow across the face of slopes, never up-and-down. Exercise extreme caution when changing direction on slopes. Do not mow excessively steep slopes.
12. Always disconnect electric mowers (line operated) before cleaning, repairing or adjusting.
13. Never operate mower without proper guards, plates or other safety protective devices in place.
14. Keep washout ports and other mower-housing service openings closed when mowing.

OPERATION

1. Do not change the engine governor settings or overspeed the engine. Excessive engine speeds are dangerous.
2. Do not put hands or feet near or under rotating parts. Keep clear of the discharge opening at all times as the rotating blade can cause injury.
3. Stop the blade when crossing gravel drives, walks or roads.

MAINTENANCE AND STORAGE

1. Check the blade and engine mounting bolts at frequent intervals for proper tightness.
2. Keep all nuts, bolts, and screws tight to be sure the equipment is in safe working condition.
3. Never store the equipment with gasoline in the tank inside of a building where fumes may reach an open flame or spark. Allow the engine to cool before storing in any enclosure.
4. To reduce fire hazard, keep the engine free of grass, leaves, or excessive grease.
5. Check the grass catcher bag frequently for wear or deterioration. For safety protection, replace only with new bag meeting original equipment specifications.

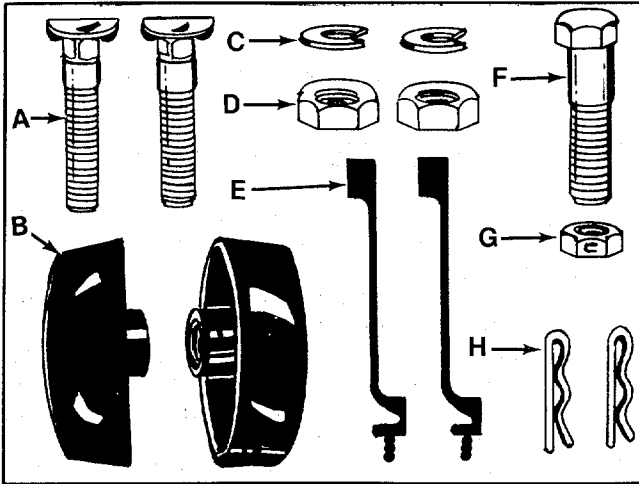

FIGURE 1.

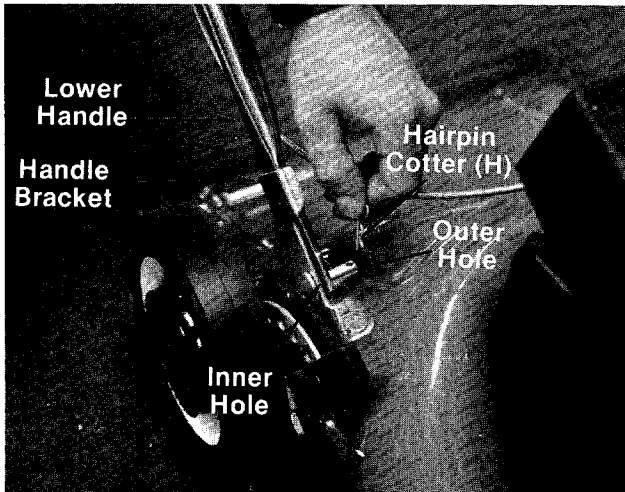

FIGURE 2.

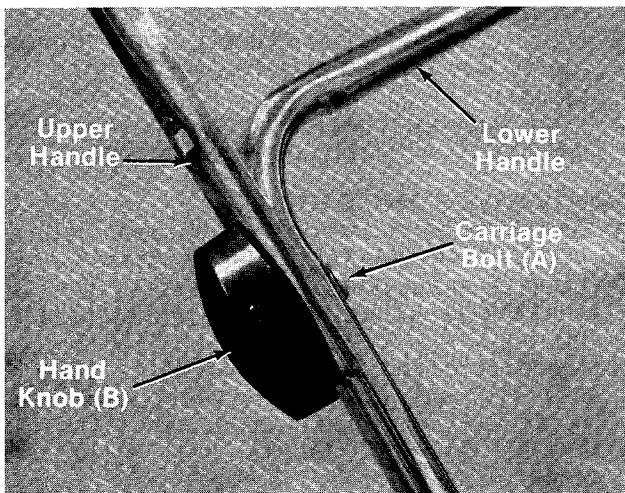

FIGURE 3. Folding Handle Only

ASSEMBLY INSTRUCTIONS

NOTE

This unit is shipped WITHOUT GASOLINE or OIL. After assembly, see operating section of this manual for proper fuel and engine oil recommendations.

1. Remove lawn mower and loose parts from carton. Make certain all parts and literature have been removed from the carton before the carton is discarded.
2. Extend throttle control which is attached to the engine at the rear of the mower and place on the floor. Be careful not to bend or kink control wire.

Contents of hardware pack: (See Figure 1)

- A (2) Curved Head Carriage Bolts
- B (2) Hand Knobs (Folding Handle Only)
- C (2) Lock Washers 5/16" I.D. (Non-Folding Handle Only)
- D (2) Hex Nuts 5/16-18 Thread (Non-Folding Handle Only)
- E (2) Cable Ties
- F (1) Hex Bolt 1/4-20 x 1.50" Long
- G (1) Hex Lock Nut 1/4-20 Thread
- H (2) Hairpin Cotters

3. Fasten lower handle in position over weld pins in handle mount brackets on deck. Secure with hairpin cotters (H) in inner hole on weld pin. See figure 2.

NOTE

There are two (2) holes in the handle mount brackets. Place the hairpin cotter in the inner hole for operation. Outer hole is for storage.

NOTE

It may be necessary to spread the ends of the lower handle to obtain a tight fit against the handle mount brackets.

4. There are two height positions for the handle. Place upper handle in position over lower handle, selecting hole for either high or low position. Refer to figure 14.

A. Units with Folding Handle—Secure upper handle with two curved carriage bolts (A) and hand knobs (B) as shown in figure 3. The knobs may be assembled either to the inside or the outside of the handle.

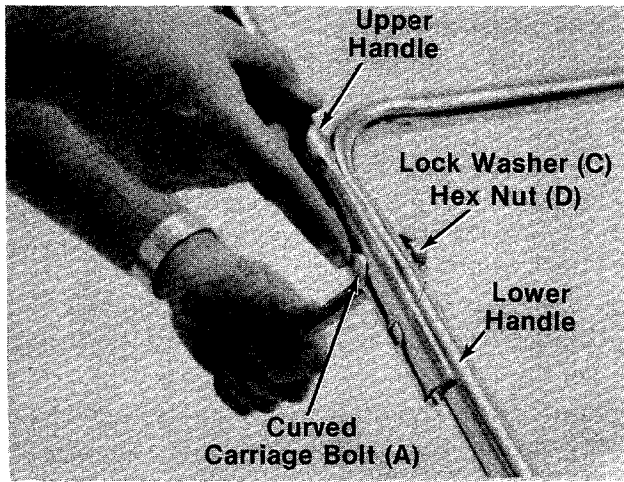

FIGURE 4. Non-Folding Handle Only

B. Units with Non-Folding Handle—Secure upper handle with two curved carriage bolts (A), lock washers (C) and hex nuts (D). See figure 4.

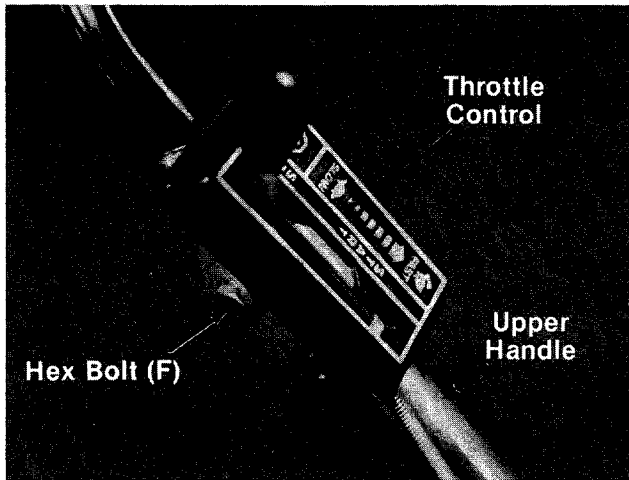

FIGURE 5.

5. Place the throttle control in position on right side of upper handle. Secure with hex bolt (F) and lock nut (G). See figure 5.

NOTE

Reference to right or left hand side of the mower is observed from the operating position.

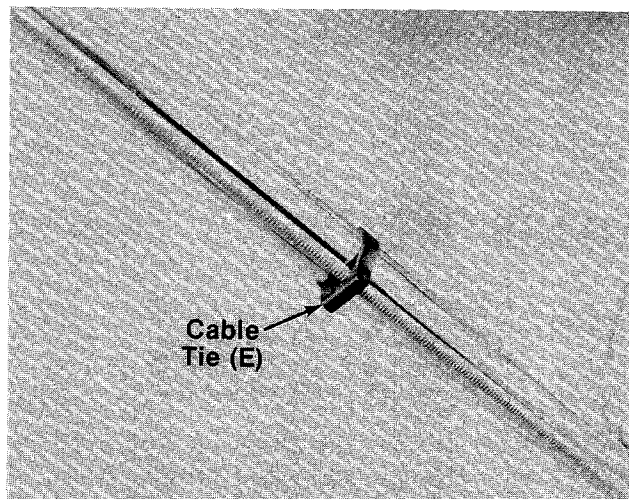

FIGURE 6.

6. Secure throttle control wire to upper and lower handles with cable ties (E). See figure 6.

7. Check ALL nuts and bolts for correct tightness.

NOTE

This mulching mower is shipped with the mulcher baffle and mulcher blade in place. If you wish to just mow, a standard cutting blade is available as optional equipment. See adjustment section for procedure to change blades.

OPERATION

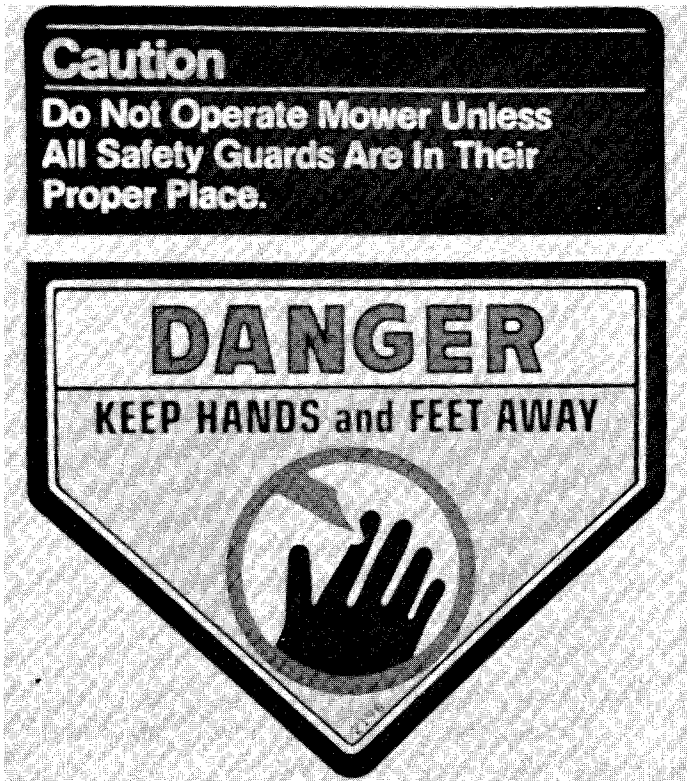

FIGURE 7.

Keep hands and feet away from the chute area on cutting deck. See figure 7.



NOTE

For shipping purposes your mower is set with the wheels in a low cutting height position. For best results, raise the cutting position until it is determined which height is best for your lawn. See adjustment section.

BEFORE STARTING

1. Fill sump with oil, using a high quality detergent oil classified "For Service SC, SD, SE or MS." Use viscosity grade SAE 30 or SAE 10W-30. Nothing should be added to the recommended oil.

Place the engine level. Remove oil fill plug and fill oil sump full to point of overflowing. On units equipped with an extended oil fill and dipstick, fill to the full mark on dipstick. Pour slowly. Capacity 1-1/4 pints.

2. Fill fuel tank, using clean, fresh, leaded **regular** grade automotive gasoline. **Fill tank completely!**

DO NOT MIX OIL WITH GASOLINE.

3. Attach spark plug wire to spark plug.

START ENGINE

1. Move throttle control lever to "START" position.
2. Crank engine, by pulling recoil starter with a quick firm pull. Do not pull out so far that rope stops with a jerk as this will cause rope failure. Do not allow rope and handle to snap back into place.
3. After two or three full firm pulls on recoil, or as soon as engine fires, move throttle control to run position.

Operate a new engine at intermediate speeds and light load for the first few hours as you would a new automotive engine.

TO STOP ENGINE

1. To stop engine, move throttle control lever to "STOP" position.
2. Remove spark plug wire from spark plug to prevent accidental starting while equipment is unattended.



NOTE

If carburetor needs adjustment to start or for operation, see adjustment section.



IMPORTANT

If you strike a foreign object, stop the engine. Remove wire from spark plug. Thoroughly inspect the mower for any damage, and repair the damage before restarting and operating the mower.

ADJUSTMENTS



Always remove the spark plug wire from the spark plug and ground it against the engine block before making any adjustments. See figure 8.

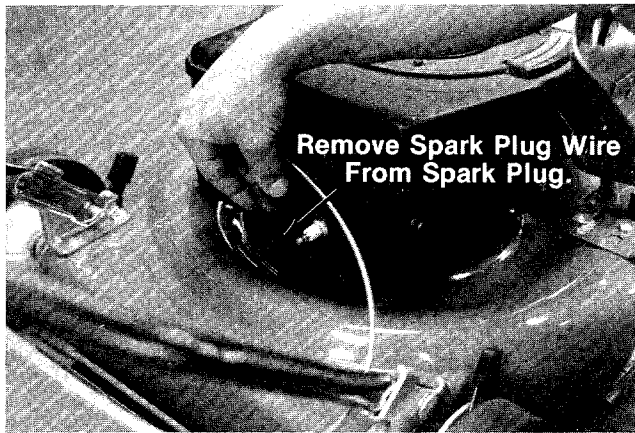

FIGURE 8.
CHANGING BLADES
 (Standard blade is available as optional equipment.)

An adjustable wrench is required to remove or install the mulching baffle and blade on the mower.

1. Remove the hex spacer stop and lock washer shown in figure 9. Remove the hex nut and lock washer shown in figure 10. Remove the mulching baffle.

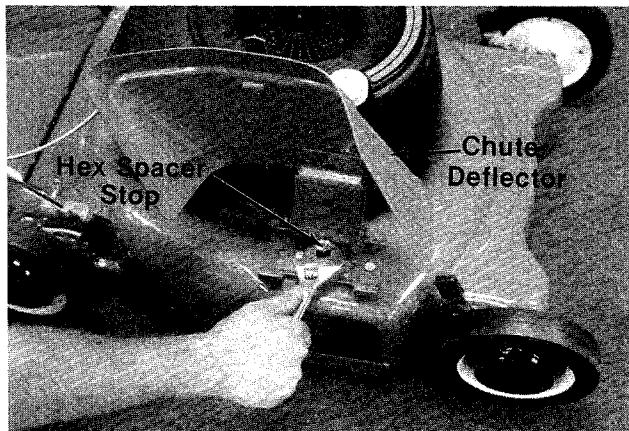

FIGURE 9.

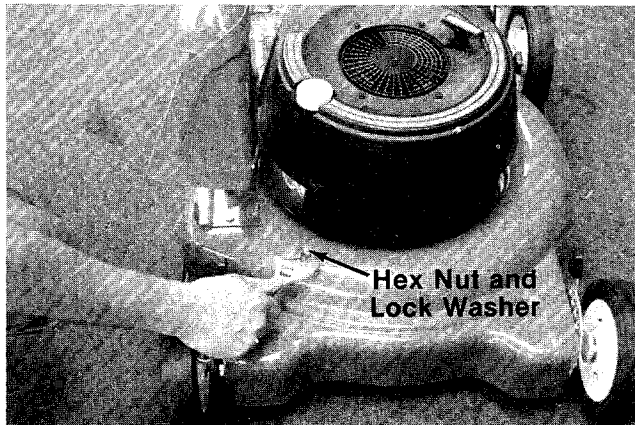

FIGURE 10.

2. Remove the mulching blade by removing only the center bolt and lock washer. A 9/16" box wrench or an adjustable wrench is required. Hold the blade with a rag to prevent cutting your hand. See figure 11.

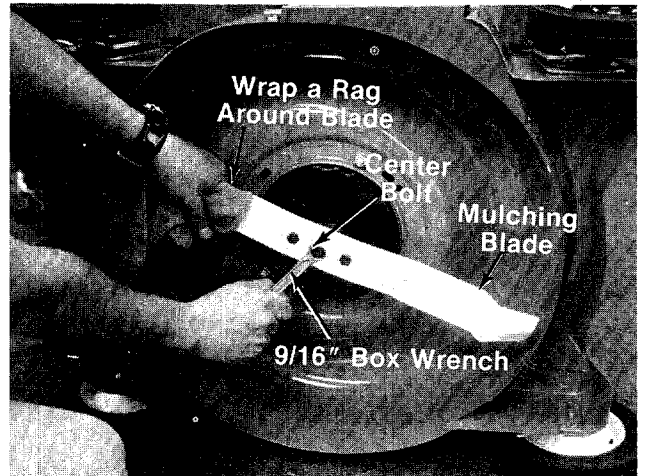

FIGURE 11.

3. Install the standard cutting blade by replacing the center bolt and lock washer. Tighten securely. Again, hold the blade with a rag for safety. See figure 12.

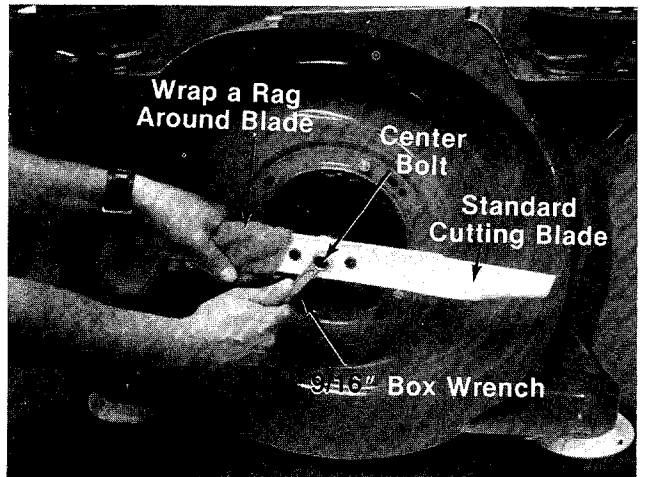

FIGURE 12.

4. For normal mowing, you should have removed the items shown in figure 13. Have the standard blade installed and the chute deflector down.

To reinstall mulching blade, reverse the preceding steps.



Apply a little grease on crankshaft when changing blades.

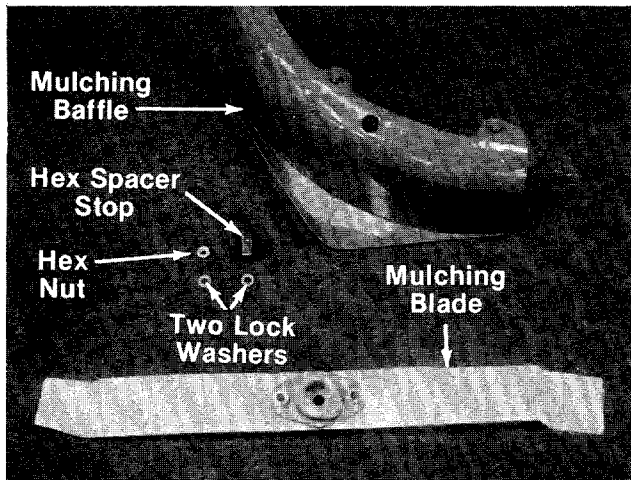

FIGURE 13.

CUTTING HEIGHT

An adjusting plate and thumb lever at each wheel position provides cutting height adjustment. Each adjusting plate has five holes. Height of cut will be changed when the thumb lever is moved from one hole to another. Simply depress thumb lever towards wheel and move wheel and lever assembly to desired position. All wheels must be placed in the same relative position.

HANDLE POSITION

The upper handle can be adjusted to a high or low position. The adjustment is made by removing the two knobs or hex nuts and lock washers, removing the two curved carriage bolts and reassembling in the other position. See figure 14.

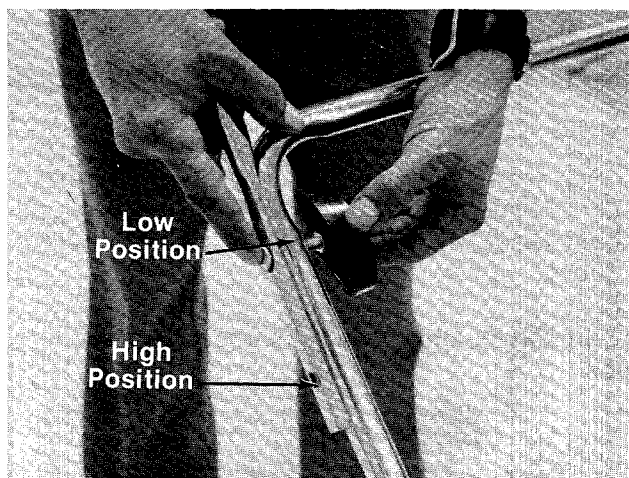

FIGURE 14.

THROTTLE

If adjustment becomes necessary, the throttle control wire assembly can be reset as follows:

1. Loosen, but do not remove, screw securing throttle control wire assembly at engine.
2. Move throttle control lever on handle to "FAST" position.
3. Move lever, to which control wire is fastened at engine, to full open position and retighten screw to secure throttle control wire assembly.



If any adjustments are made to the engine while the engine is running (e.g. carburetor), disengage all clutches and blades. Keep clear of all moving parts. Be careful of heated surfaces and muffler.

CARBURETOR ADJUSTMENT (See Figure 15)

Minor carburetor adjustment may be required to compensate for differences in fuel, temperature, altitude and load.

All carburetor adjustments should be made with the air cleaner on engine. Air cleaner mounting screw **must** be in carburetor when engine is run. Best adjustment is made with a fuel tank half full of gasoline. To adjust carburetor, proceed as follows.

1. Start engine and run long enough to warm it to operating temperature.

If engine is out of adjustment so that it will not start, close the needle valve by turning it clockwise. Then open needle valve 1½ turns counterclockwise.
2. Move engine control to run engine at normal operating speed.
 - a. Turn needle valve in clockwise until engine starts to lose speed (lean mixture).
 - b. Then slowly turn needle valve out counterclockwise past the point of smoothest operation until engine just begins to run unevenly (rich mixture).
 - c. Turn needle valve back in clockwise very slowly till engine runs evenly.
 - d. Final adjustment of the needle valve should be slightly to the rich side (turn counterclockwise) of the mid-point.

3. Move engine control to SLOW. Turn idle adjusting screw until a fast idle is obtained—(1750 R.P.M.).
4. To check adjustment, move engine control from SLOW to FAST speed. Engine should accelerate smoothly. If engine tends to stall or die out, increase idle speed or readjust carburetor, usually to a slightly richer mixture.

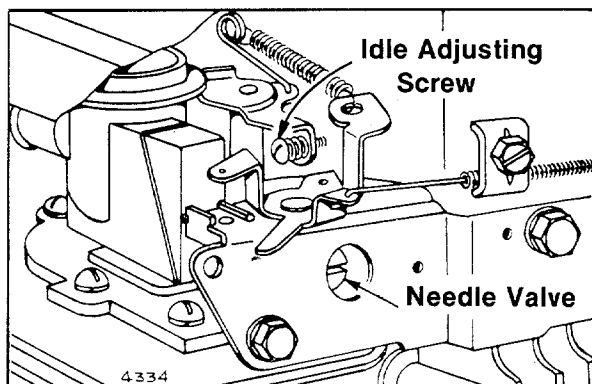

FIGURE 15.

LUBRICATION



Always stop engine and disconnect spark plug wire before cleaning, lubricating or doing any kind of work on lawn mower.

Wheels—Mower may be provided with ball bearing wheels. Lubricate at least once a season with light oil.

Also, if the wheels are removed for any reason, lubricate the surface of the axle bolt and the inner surface of the wheel with light oil. A 4 oz. plastic bottle of light oil lubricant is available. Order part number 737-0170. Engine oil may also be used.

Throttle—Periodically lubricate throttle control lever and throttle wire assembly with a few drops of light oil for ease of operation.

Protective Shield—The pivot points on the protective shield should be lubricated periodically with light oil to prevent any rust or binding up.

Chute Deflector—The torsion spring and pivot point should be lubricated periodically with light oil to prevent any rust or binding up. Deflector should work freely.

MAINTENANCE

CUTTING BLADE

A. Removal for Sharpening or Replacement



Be sure to disconnect and ground the spark plug wire before working on the cutting blade to prevent accidental engine starting.

1. Remove the large bolt and lock washer which holds the blade and adapter to the engine crankshaft.
2. Remove the blade and adapter from the crankshaft. Be careful not to lose the key on the crankshaft.
3. If the blade or blade adapter needs replacing, remove the two small bolts, lock washers and nuts which hold the blade to the adapter.

B. Sharpening

Remove the cutting blade by following the directions of the preceding section.

When sharpening the blade, follow the original angle of grind as a guide. It is **extremely important** that each cutting edge receives an equal amount of grinding to prevent an unbalanced blade. An unbalanced blade will cause excessive vibration when rotating at high speeds, may cause damage to the mower and could break, causing personal injury.

The blade can be tested for balance by balancing it on a round shaft screwdriver. Remove metal from the heavy side until it balances evenly.



It is recommended that the blade always be removed from the adapter for the best test of balance.

C. Reassembly

Before reassembling the blade and the blade adapter to the unit, lubricate the engine crankshaft and the inner surface of the blade adapter with light oil. Lubricating the bolt holes, bolts and inner surface of the nuts with light oil is also recommended. A 4 oz. plastic bottle of light oil lubricant is available. Order part number 737-0170. Engine oil may also be used.

When replacing the blade, be sure to install the blade with the side of the blade marked "Bottom" (or with part number) facing the ground when the mower is in the operating position. Make certain key is in place on the crankshaft.

Blade Mounting Torque

3/8" Dia. Bolt 375 in. lb. min., 450 in. lb. max.

5/16" Dia. Bolt 150 in. lb. min., 250 in. lb. max.

To insure safe operation of your unit, ALL nuts and bolts must be checked periodically for correct tightness.

DECK

The underside of mower deck should be cleaned after each period of use as grass clippings, leaves, dirt and other matter will accumulate. This accumulation of grass clippings, etc., is undesirable as it will invite rust and corrosion and may cause an uneven discharge of grass clippings at the next cutting.

The deck may be cleaned by tilting the mower forward or on its side and scraping clean with a suitable tool or by washing with a stream of water from a garden hose.



CAUTION

Do not direct the stream of water at a hot engine as damage to the engine may result.

ENGINE OIL

Check oil level before starting engine and after every 5 hours of operation. Add oil as necessary to keep level full to point of overflowing or to full mark on dipstick. Before removing oil cap, clean area around cap to prevent dirt from entering oil sump. Engine should be in a level position when checking oil.

Change oil after first 5 hours of operation. Thereafter change every 25 hours. Change oil while engine is warm. Oil may be drained thru drain on bottom of engine. To drain completely, always place engine level when draining thru the bottom. Oil capacity 1-1/4 pints.

AIR CLEANER

Clean air cleaner and re-oil element every 25 hours under normal conditions. Clean every few hours under extremely dusty conditions. Poor engine performance and flooding usually indicates that the air cleaner should be serviced. See figure 16.

To service air cleaner:

1. Remove screw.
2. Remove air cleaner carefully to prevent dirt from entering carburetor.

3. Take air cleaner apart and clean.
 - a. WASH foam element in kerosene or a liquid detergent and water to remove dirt.
 - b. DRY foam completely by wrapping and squeezing in a cloth.
 - c. SOAK foam with engine oil. Squeeze to distribute and remove excess oil.
4. Reassemble parts and fasten to carburetor.

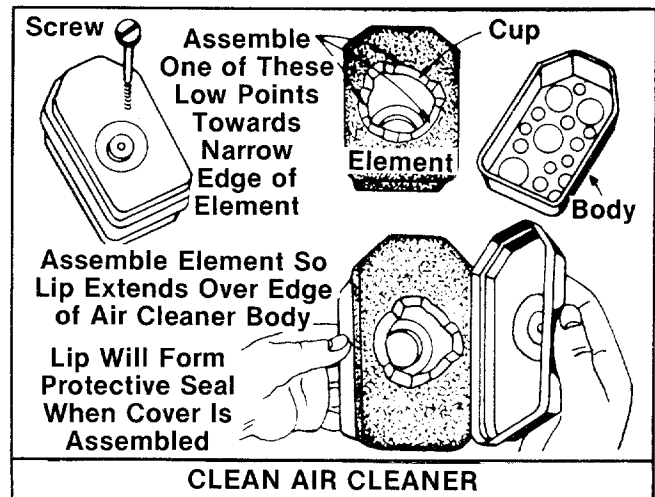

FIGURE 16.

SPARK PLUG

The spark plug should be cleaned (see figure 17) and the gap reset to a 0.030-inch clearance once a season (see figure 18). Spark plug replacement is recommended at the start of each mowing season; check engine manual for correct plug type.

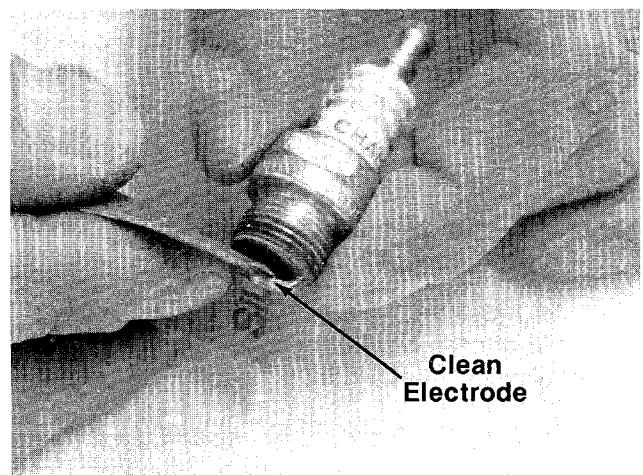

FIGURE 17.

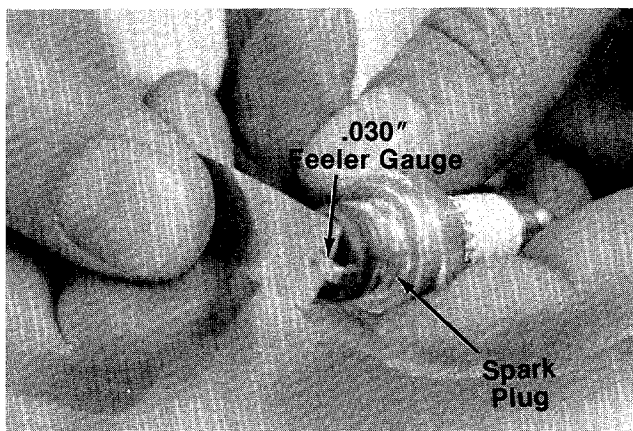

FIGURE 18.

OFF-SEASON STORAGE

The following steps should be taken to prepare lawn mower for storage.

1. Clean and lubricate mower thoroughly as described in the lubrication instructions.
2. Refer to engine manual for correct engine storage instructions.
3. Coat mower's cutting blade with chassis grease to prevent rusting.
4. Place blocks under deck to raise tires clear of floor.
5. Store mower in a dry, clean area.

HANDLE STORAGE

The handle may be placed in an upright position for storage.

Move the hairpin cotters to the outer hole on weld pins. See figure 2. Press inward on the bottom of the lower handle and push forward. The handle will lock in this position. See figure 19.

Reverse the above procedure to place the handle in the operating position.

On units with folding handles, the handle may be folded away completely for storage.

1. Remove hairpin cotters from inner hole on weld pins on handle mount brackets. Place in outer hole. See figure 2.
2. Loosen the two hand knobs on each side of the handle.
3. Pull inward on the bottom of each side of the lower handle and push forward. See figure 19.
4. Fold the upper handle back and down as shown. See figures 20 and 21.

To take the handle out of storage position:

1. Lift the upper handle up and towards the rear as shown.

2. Pull the handle back until it **locks** into the operator's position.
3. Tighten the two hand knobs securely.
4. Move the hairpin cotters to the inner hole on the weld pins.



FIGURE 19.

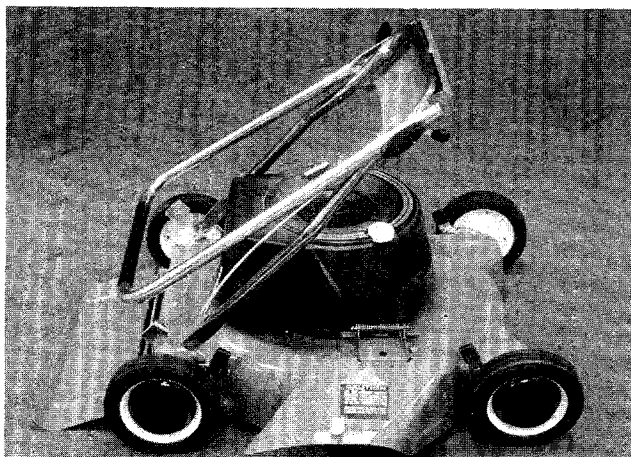

FIGURE 20. Units With Folding Handle

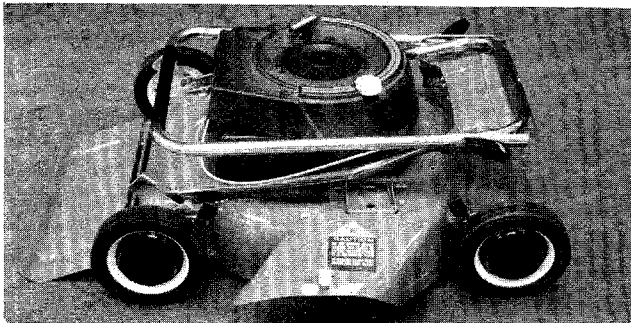

FIGURE 21. Units With Folding Handle

 **NOTE**

The use of any accessory on this Rotary Mower other than those manufactured by the mower manufacturer is **not** recommended.

GRASS CATCHER Model 004 is available as optional equipment for the mowers shown in this manual.



1. The mower should not be operated without the entire grass catcher or chute deflector in place.
2. The mower should not be operated without the protective shield on the rear of the deck in place.

 **NOTE**

Under normal usage bag material is subject to wear and should be checked periodically. Be sure any replacement bag complies with the mower manufacturer's recommendations.

For replacement bags, use only factory authorized replacement bag No. 764-0176.

NOTES

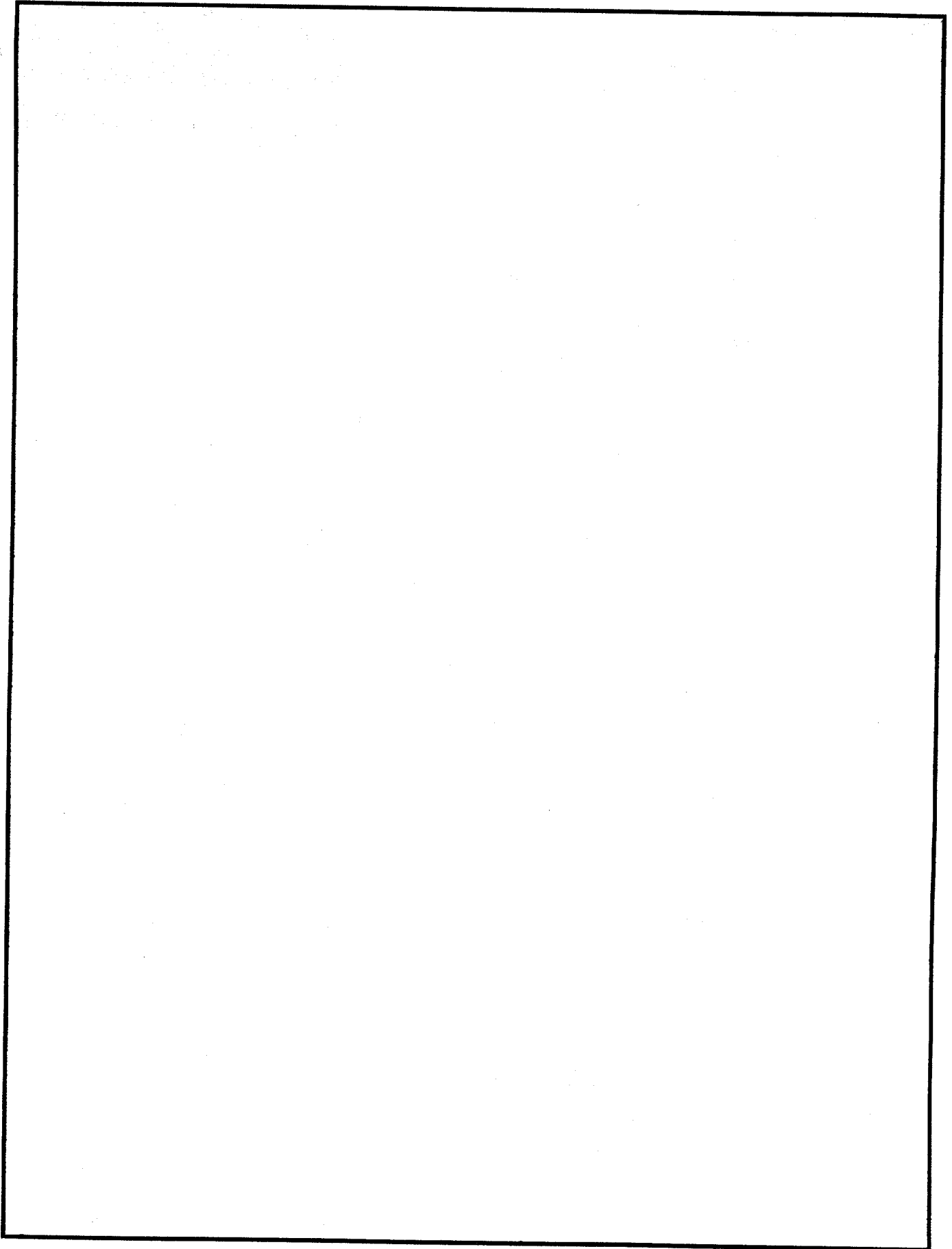

Model 170

IF YOU WRITE TO US ABOUT THIS ARTICLE
OR IF YOU ORDER REPLACEMENT PARTS AL-
WAYS MENTION THIS MODEL & SERIAL NO
MODEL

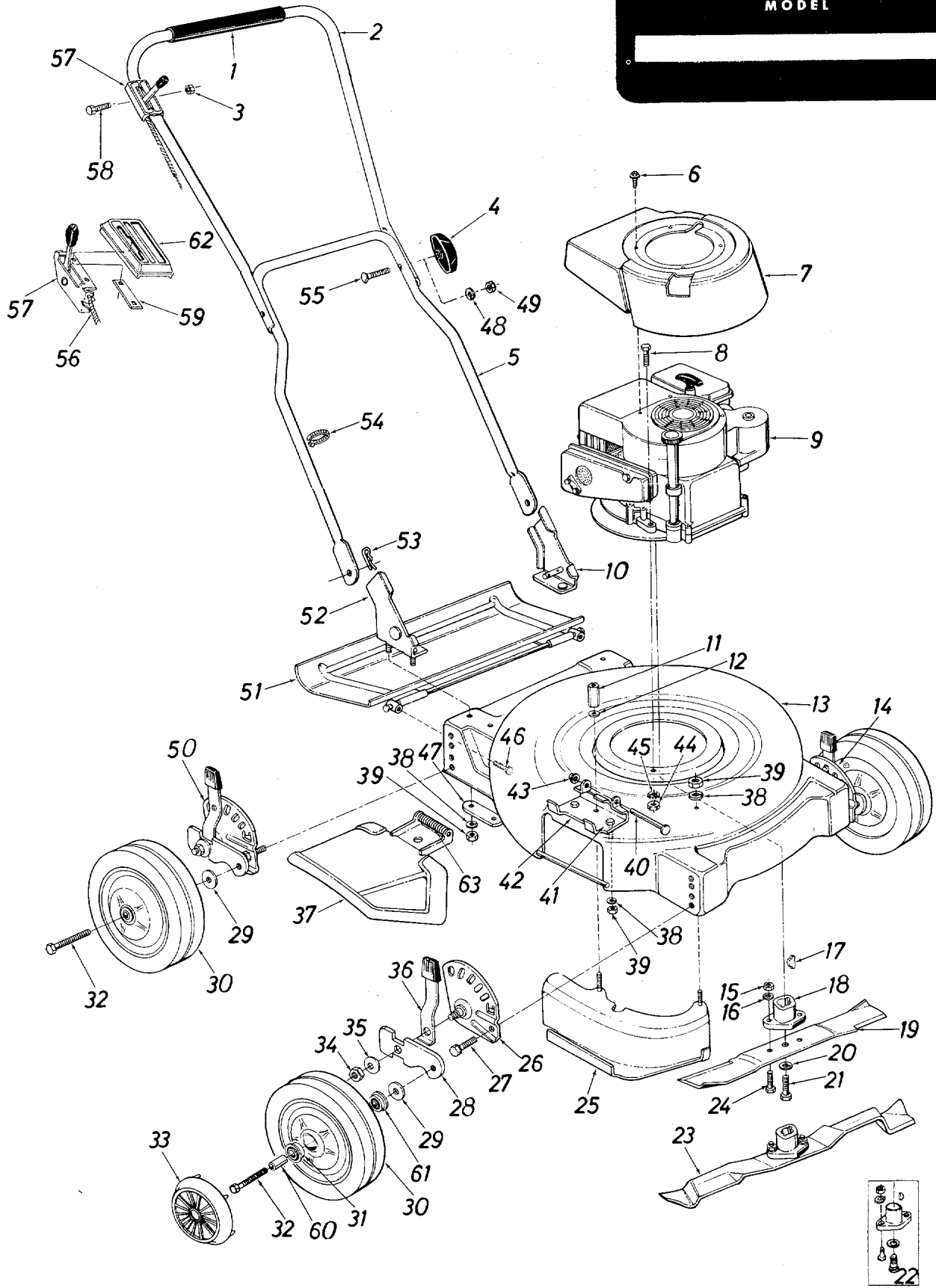

Model 170

PARTS LIST FOR MODEL 170 ROTARY MOWER

REF. NO.	PART NO.	COLOR CODE	DESCRIPTION	NEW PART	REF. NO.	PART NO.	COLOR CODE	DESCRIPTION	NEW PART
1	718-0145		Grip		33	**		Hub Cap (See Below)†	
2	749-0384		Upper Handle (Chrome)		34	712-0116		Hex Ins. Jam L-Nut 3/8-24 Thd.	
	749-0465		Upper Handle (Painted)						
3	712-0107		Hex Cent. L-Nut 1/4-20 Thd.		35	736-0219		Bell-Wash. .40 I.D. x 1.12 O.D. x .03	
4	09966		Hand Knob†						
5	749-0449		Lower Handle (Chrome)		36	14082		Spring Lever Ass'y. w/Knob	
	749-0448		Lower Handle (Painted)		37	11679	—462	Chute Deflector Ass'y. Comp.	
6	710-0227		Hex AB Tap. Scr.—#8 x .50" Lg.†		38	736-0329		L-Wash. 1/4" I.D.*	
7	731-0276		Shroud—Plastic†		39	712-0287		Hex Nut 1/4-20 Thd.*	
8	710-0158		Hex Bolt 5/16-24 x 1.50" Lg. Engine		40	711-0555		Pivot Pin	
9	—				41	710-0289		Hex Bolt 1/4-20 x .50" Lg.*	
10	12945		Handle Mounting Brkt.—L.H.		42	11130	—462	Deflector Hinge Plate	
11	711-0685		Hex Spacer Stop		43	726-0106		Push Nut for 1/4" Rod	
12	736-0329		L-Wash. 1/4" I.D.*		44	712-0123		Hex Nut 5/16-24 Thd.*	
13	13679	—462	20" Deck Ass'y.		45	736-0119		L-Wash. 5/16" I.D.*	
14	10941		Height Adj. Ass'y. w/Black Knob—L.H.		46	710-0567		Hex Sems Scr. 1/4-28 x .62" Lg.*	
15	712-0123		Hex Nut 5/16-24 Thd.		47	08405		Reinforcement Plate	
16	736-0119		L-Wash. 5/16" I.D.*		48	736-0119		L-Wash. 5/16" I.D.*†	
17	714-0365		#6 Hi-Pro Key 5/32" x 5/8" Dia.		49	712-0267		Hex Nut 5/16" Thd.*†	
18	10769		Blade Adapter Kit		50	10938		Height Adj. Ass'y. w/Knob—R.H.	
19	742-0123		20" Standard Blade†		51	11193	—462	Rear Shield Ass'y. Comp.	
20	736-0217		H Spring L-Wash. for 3/8" Scr.*		52	12946		Handle Mtg. Brkt. Ass'y.—R.H.	
21	710-0459		Hex Bolt 3/8-24 x 1.50" Lg.		53	714-0104		Intern. Cotter Pin 5/16" Dia.	
22	10769		Blade Adapter Kit		54	726-0188		Cable Tie	
23	742-0213		20" Mulching Blade		55	710-0405		Curved Carriage Bolt 5/16-18 x 1.75" Lg. (Folding Handle)†	
24	710-0117		Hex Bolt 5/16-24 x 1.00" Lg.					Curved Carriage Bolt 5/16-18 x 1.38" Lg. (Non-Folding Handle)†	
25	13854		Mulching Baffle Ass'y.						
26	10934		Index Plate Ass'y.—R.H.			710-0371			
27	710-0209		Hex Sems Scr. 3/8-16 x .62" Lg.*						
28	10937		Pivot Bar		56	746-0381		Conduit and Wire	
29	736-0105		Bell-Wash. .40" I.D. x .88" O.D. x .06		57	746-0380		Throttle Control Ass'y. Comp.	
30	734-0844		Wheel Ass'y. Comp. (Steel)		58	710-0606		Hex Bolt 1/4-20 x 1.50" Lg.*	
	734-0840		Wheel Ass'y. Comp. (Plastic)		59	726-0134		Speed Nut #8-32 Twin Type	
31	741-0484		Ball Bearing—1/2" I.D.†		60	750-0434		Spacer†	
32	710-0347		Hex Bolt 3/8-16 x 1.75" Lg.* (Used w/Ball Bearing)†		61	741-0267		Ball Bearing—3/8" I.D.†	
	738-0102		Shoulder Bolt (Used w/Plastic Wheels)†		62	731-0344		Plastic Cover	
					63	732-0253		Torsion Spring	

† Optional Part

*For faster service obtain standard nuts, bolts and washers locally. If these items cannot be obtained locally, order by part number and size as shown on parts list.

(462—Red Flake)
(486—Star Orange)

**Hub Caps (Optional)

Color	Part No.
Red	731-0124
Orange	731-0254
Black	731-0354
Gray	731-0355

When ordering parts, if color or finish is important use the appropriate color code shown above. (e.g. Red Flake Finish—13679 (462).)

NOTE: Mulcher kit is available under Kit No. 753-0213.



This instruction manual covers various models and all specifications shown do not necessarily apply to your model. Specifications subject to change without notice or obligation.

NOTE: The engine is not under warranty by the mower manufacturer . . . If repairs or service is needed on the engine, please contact your nearest authorized engine service outlet. Check the "Yellow Pages" of your telephone book under "Engines—Gasoline."

**Find It Fast
In the
Yellow Pages**

PARTS INFORMATION

POWER EQUIPMENT PARTS AND SERVICE

Parts and service for all MTD manufactured power equipment are available through the authorized service firms listed below. All orders should specify the model number of your unit, part numbers, description of parts and the quantity of each part required.

NOTE: If any parts are found to be missing or defective upon assembly of this unit, write to advise the factory so that immediate replacement can be made.

ALABAMA	BIRMINGHAM	
Auto Electric & Carburetor Co.	2625 4th Ave. S.	35233
ARKANSAS	FORT SMITH	
Mity Mite Motors, Inc.	4515 S. 16th St.	72901
	NORTH LITTLE ROCK	
Sutton's Lawn Mower Shop	Rt. 4, Box 368	72117
CALIFORNIA	PORTERVILLE	
Billious	75 North D Street	93257
COLORADO	DENVER	
Spitzer Industrial Products Co.	6601 N. Washington St., Box 29114	80229
FLORIDA	JACKSONVILLE	
Radco Distributors	4909 Victor St., Box 5459	32207
	OPA LOCKA	
Small Eng. Dist.	2351 N.W. 147th St.	33054
GEORGIA	EAST POINT	
East Point Cycle & Key	2834 Church St.	30344
ILLINOIS	LYONS	
Keen Edge Co.	8615 Ogden Ave.	60534
INDIANA	ELKHART	
Parts & Sales Inc.	2101 Industrial Pkwy.	46514
IOWA	DUBUQUE	
Power Lawn & Garden Equip.	2551 J.F. Kennedy	52001
LOUISIANA	NEW ORLEANS	
Suhren Engine Co.	8330 Earhart Blvd.	70118
MARYLAND	TAKOMA PARK	
Center Supply Co.	6867 New Hampshire Ave.	20012
MASSACHUSETTS	SPRINGFIELD	
Morton B. Collins Co.	300 Birnie Ave.	01107
MICHIGAN	LANSING	
Lorenz Service Co.	2500 S. Pennsylvania	48910
	MOUNT CLEMENS	
Power Equipment Dist.	340 Hubbard	48043
MINNESOTA	HOPKINS	
Hance Distributing Inc.	420 Excelsior Ave. W.	55343
MISSISSIPPI	BILOXI	
Biloxi Sales & Service, Inc.	506 Caillavet St.	39533
MISSOURI	KANSAS CITY	
Automotive Equip. Service	3117 Holmes St.	64109
	ST. JOSEPH	
Ross-Frazier Supply Co.	8th and Monterey	64503
	ST. LOUIS	
Henzler, Inc.	2015 Lemay Ferry Rd.	63125
NEW JERSEY	BELLMAWR	
Lawnmower Parts Inc.	717 Creek Rd.	08030
NEW MEXICO	ALBUQUERQUE	
Spitzer Eng. & Parts	1023 Third St. N.W.	87103
NEW YORK	CARTHAGE	
Gamble Dist., Inc.	West End Ave.	13619

BRIGGS AND STRATTON, TECUMSEH AND PEERLESS PARTS AND SERVICE

Briggs & Stratton, Tecumseh and Peerless parts and service should be handled by your nearest authorized engine service firm. Check the yellow pages of your telephone directory under the listing **Engines—Gasoline**, Briggs & Stratton or Tecumseh Lauson.

NORTH CAROLINA	GOLDSBORO	
Smith Hardware Co.	515 N. George St.	27530
	GREENSBORO	
Dixie Sales Company	335 N. Green	27402
OHIO	CARROLL	
Stebe's Mid-State Mower Supply	71 High St., Box 366	43112
	CLEVELAND	
Bleckrie, Inc.	7900 Lorain Ave.	44102
	WADSWORTH	
National Central	687 Seville Rd.	44281
	YOUNGSTOWN	
Burton Supply Co.	1301 Logan Ave., Box 929	44501
OKLAHOMA	MUSKOGEE	
Victory Motors, Inc.	605 S. Cherokee	74401
OREGON	PORTLAND	
Kenton Supply Co.	8216 N. Denver Ave.	97217
PENNSYLVANIA	HARRISBURG	
EECO Inc.	4021 N. 6th St.	17110
	PHILADELPHIA	
Thompson Rubber Co.	5222-24 N. Fifth St.	19120
	PITTSBURGH	
Bluemont Co.	11125 Frankstown Rd.	15235
	PUNXSUTAWNEY	
Frank Roberts & Sons	R.D. 2	15767
TENNESSEE	KNOXVILLE	
Master Repair Service	2000 Western Ave.	37921
	MEMPHIS	
American Sales & Service, Inc.	3035-43 Bellbrook	381
TEXAS	DALLAS	
Marr Brothers, Inc.	423 E. Jefferson	75203
	FORT WORTH	
Woodson Sales Corp.	1702 N. Sylvania	76111
	HOUSTON	
Bullard Supply Co.	2409 Commerce St.	77003
UTAH	SALT LAKE CITY	
A-1 Engine & Mower Co.	437 E. 9th St.	84111
VERMONT	BURLINGTON	
Vermont Hdwe. Co. Inc.	180 Flynn Ave.	05401
VIRGINIA	ASHLAND	
RBI Corp.	Lake Ridge Park, 101 Cedar Run Dr.	23005
WASHINGTON	SEATTLE	
Bailey's Inc.	1414 14th Ave.	98102
WEST VIRGINIA	CHARLESTON	
Young's, Inc.	233 Virginia St., E.	25301
WISCONSIN	MARSHFIELD	
Power Pac	301 E. 29th St.	54449

WARRANTY PARTS AND SERVICE POLICY

The purpose of warranty is to protect the customer from defects in workmanship and materials, defects which are NOT detected at the time of manufacture. It does not provide for the unlimited and unrestricted replacement of parts. Use and maintenance are the responsibility of the customer. The manufacturer cannot assume responsibility for conditions over which it has no control. Simply put, if it's the manufacturer's fault, it's the manufacturer's responsibility; if it's the customer's fault, it's the customer's responsibility.

CLAIMS AGAINST THE MANUFACTURER'S WARRANTY INCLUDES:

1. Replacement of Missing Parts on new equipment.
2. Replacement of Defective Parts within the warranty period.
3. Repair of Defects within the warranty period.

All claims MUST be substantiated with the following information:

1. Model Number of unit involved.
2. Date unit was purchased or first put into service.
3. Date of failure.
4. Nature of failure.